

**1966
FORD** **BRONCO**

ALL-PURPOSE VEHICLE

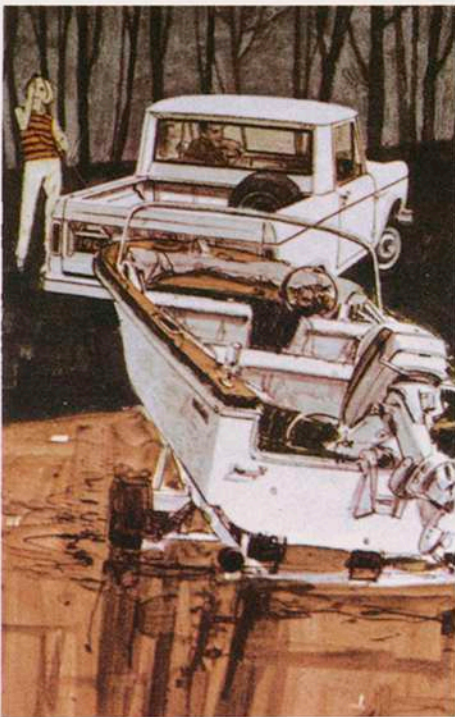

BRONCO... Ford's new 4-wheel-drive vehicle



FOR OUTDOOR RECREATION . . .

Bronco brings the great outdoors to you. Surefooted all-wheel drive takes you into uncluttered deep country and back. Designed for rugged, cross-country operation, Bronco's unique Mono-Beam front suspension smooths out the bumps; shortest turning radius of any vehicle of its type gets you around any obstacle; good ground clearance in front, under and behind minimizes chance of being "hung up."

FOR IN-CITY ERRANDS . . .

How about quick service on that special part that's holding up the job? You can count on real service when your supplier drives a Bronco, the vehicle of 1,001 uses. Ideal for city use, Bronco is nimble in tight spaces, operates very economically, shrugs off high idle, stop-and-go traffic, carries all you want to take with you within easy reach because of a full-width tailgate and one-hand-operated tailgate latch.

FOR RANCHING . . .

Bronco is a natural for farm and ranch! With special equipment, readily obtainable from or through your Ford Dealer, it will dig postholes, winch out logs, spray trees, cut grass, dig trenches, cut timber, fight fires, stalk predators . . . yes, and even herd cattle. Bronco's big 170-cu. in. six-cylinder engine and an optional power take-off runs all kinds of front- or rear-mounted auxiliary equipment. Home on the range was never like this!

BRONCO . . . DESIGNED TO GO ANYWHERE, DESIGNED TO BE VERSATILE!

In most states, your all-purpose Ford Bronco may be registered as either a passenger car or truck, depending upon the way you use the vehicle. Check with your state motor vehicle department when you buy your license plates.

takes you beyond the end of the road !



FOR CONSTRUCTION SUPERVISORS . . . Bronco is a handy vehicle for getting around a construction site. It gets you out to the job in a hurry in conventional two-wheel drive. Flick the single transfer case lever into four-wheel drive, and go barreling along over rocks and ruts right up to where you're needed. With Bronco, you don't walk to the job; you drive! No need to baby Bronco, either. Like its namesake, Bronco is a sturdy mount . . . with lots of heart and stamina.



FOR SERVICE STATION OWNERS . . . Save your heavy wrecker for the big jobs. Your Bronco can't be beat for chasing parts, taking first aid out to a motorist in distress, pushing stalled cars, making business calls, as a courtesy loaner. Hook on a snowplow or rotary broom to keep your driveways clear. Properly equipped with the many attachments available, it will push, pull, lift and lower. And you'll find driving your Bronco a pleasure, too!



FOR RALLYING . . . Like a challenge? So does Bronco. Take it along with you to the next cross-country rally, and you'll find you have a real winner! Up hill, down dale, across streams, up steep grades and over rock-strewn terrain, Bronco has the stuff that makes champions. Six-cylinder engine, fully synchronized transmission, single-lever shift with two-speed transfer case, 4-wheel drive, oil pressure gauge and ammeter are standard.

Three BRONCOS to choose from...

ROADSTER . . . The standard Bronco Roadster is an all-purpose vehicle without roof or doors. Smoothly contoured door openings give it a sporty appearance. Optional steel doors are available with or without glass and frame. A vinyl top with vinyl doors is also available. The windshield may be folded down flat on the hood and locked in place. The standard seat is a bench type with ample room for three persons. Left or left and right front bucket seats are optional and are required with the optional bench-type rear seat. A steel bulkhead between front and rear is supplied as standard equipment, but is not included when the rear seat option is selected.

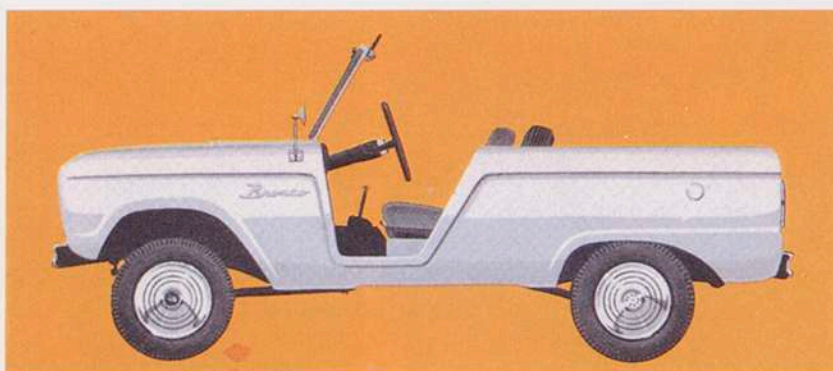

SPORTS UTILITY . . . The Sports Utility is the same as the standard Roadster except that it includes a short steel roof, metal side doors and roll-up windows to provide complete weather protection. The Sports Utility, along with the Roadster and Wagon, has full-width 56-inch tailgate with a handy one-hand-operated latch. Wheelhousings are flat on top for extra convenience. A full-width bench-type front seat is standard. Optional left or left and right front bucket seats are available. The sturdy steel roof top weighs only 70 pounds and can be unbolted and removed when desired. The double-walled rear area has over 32 cubic feet of space for your camping or other gear.

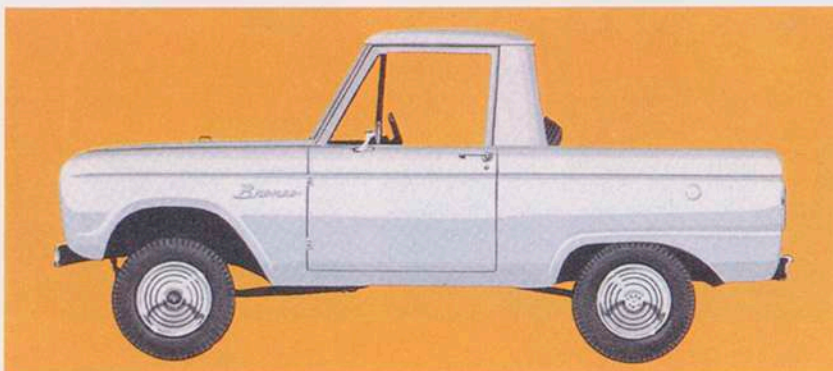

WAGON . . . The Wagon has a full-length roof with upper body sides installed on the basic body. The two driver-passenger doors are steel with roll-up windows. The upper body sides have large fixed windows. The rear liftgate also has a large fixed window and may be locked in the open position for ventilation. The tailgate may be left in the horizontal position for carrying long items. The entire enclosed area can be completely locked. The top and upper body sides are bolted on and can be removed if desired. Front bucket seats are available and required with the optional bench-type rear seat. The steel bulkhead is deleted with the rear seat option.



for unlimited versatility!

BRONCO OFFERS SEATING VERSATILITY!

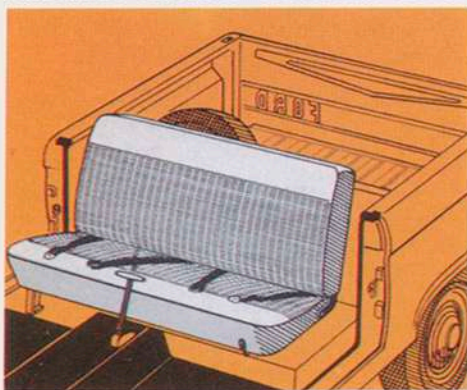

FRONT BENCH SEAT . . . A three-man, bench-type front seat is standard on all Broncos. This full-width seat offers amazing spaciousness in a utility vehicle. Bronco has a front seat travel of five full inches, a generous amount for any vehicle of its class. Two pairs of sturdy seat belts come as standard equipment.

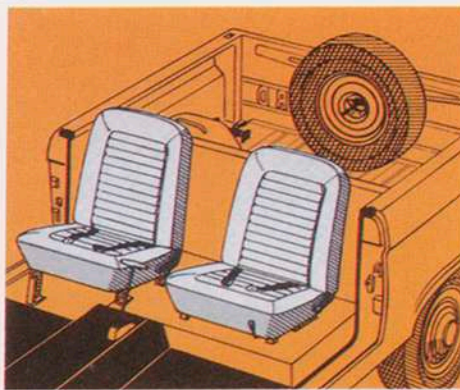

FRONT BUCKET SEATS . . . For extra comfort and luxury, attractive bucket seats are available. You may select a matching pair. If you prefer, however, you may have your Bronco equipped with a single bucket seat, leaving the right-hand side free. Seats are upholstered in handsome smooth-finished vinyl fabric.

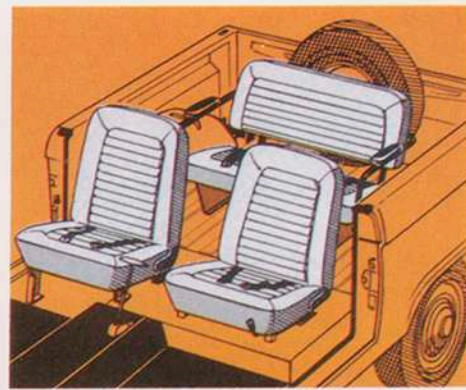

BUCKET SEATS PLUS REAR BENCH SEAT . . . Want to go sporty? You can have a pair of bucket seats installed in front with a matching bench seat in the rear. When ordered this way, the steel bulkhead is deleted, leaving plenty of space for walking through from front to rear. Rear bench seat accommodates two persons comfortably.

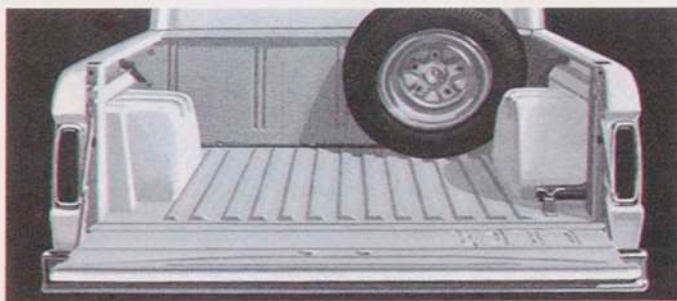

BRONCO CAPACITY: 32.1 CUBIC FEET . . . Bronco's rear area gives you plenty of space for all kinds of camping or other gear . . . and then some. The body is an integral steel unit with double sidewall construction that protects exterior sheetmetal from damage from within.



FULL-WIDTH TAILGATE—WITH ONE-HAND-OPERATED LATCH . . . The 56-inch-wide tailgate, by far the widest of any utility vehicle, lets you load bulky items with ease. Pull and the tailgate opens; push and it snaps shut . . . no hooks or chains. Very handy, especially when your arms are full.

Why BRONCO outrides them all . . .

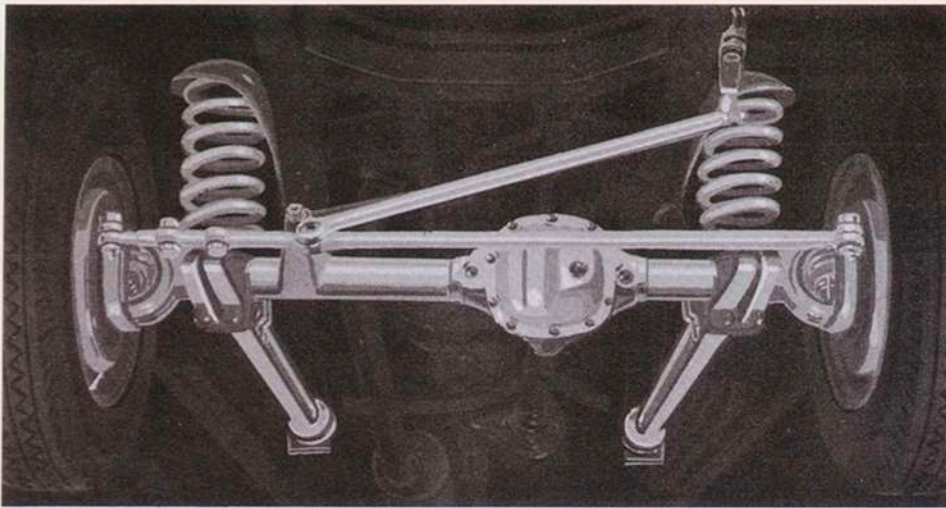

FORD'S UNIQUE MONO-BEAM SUSPENSION

Bronco's Mono-Beam front end suspension provides the finest riding quality of any vehicle of its type without sacrificing cross-country mobility and maneuverability. This is accomplished through the use of easy-riding coil springs and sturdy forged steel radius rods that attach the axle to the frame through heavy rubber insulated bushings, which absorb shock. A forged steel one-inch diameter track bar extending across the front provides lateral stability. Bronco's Mono-Beam front suspension is tough and durable . . . designed and built to take on any road, or no road at all!

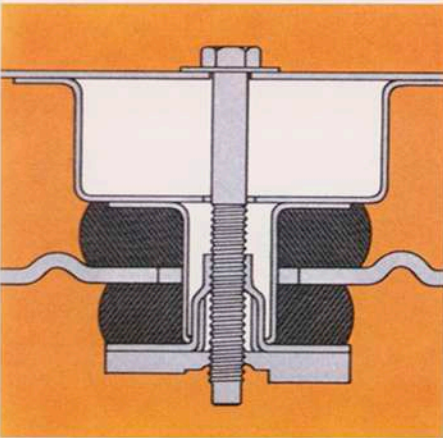

CUSHIONED BODY MOUNTS

Eight heavy rubber cushions, mounted between the body and chassis, soak up noise and vibration . . . make driving more comfortable and quiet even over the roughest terrain.

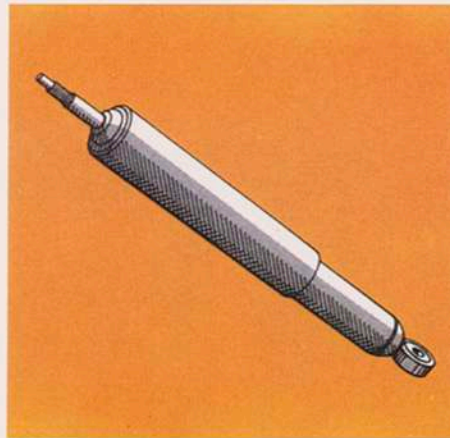

SHOCK ABSORBERS

Four double-action, telescopic shock absorbers, featuring all-weather multi-viscosity fluid, are provided as standard equipment on the Bronco. Rear shock absorbers are outboard-mounted.

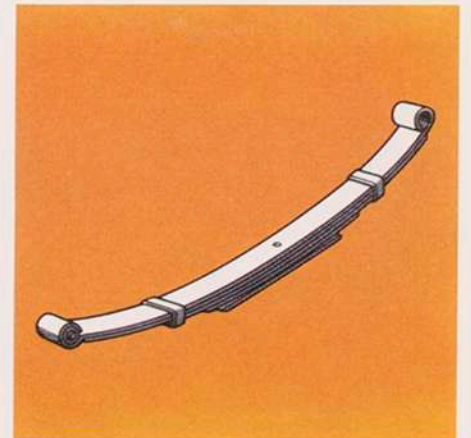

PROGRESSIVE REAR SPRINGS

Progressive-type rear main springs are built to give a smooth ride whether running empty or with a full load. Their long, wide design provides unusual stability, durability and sturdiness.

and outhandles them all

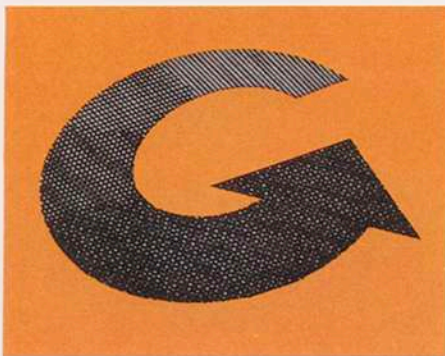

TURNING . . . The Bronco turns in a 33.6-ft. turning diameter . . . less than any other comparable utility vehicle. This ability to turn in a small area comes in mighty handy going 'round obstacles.

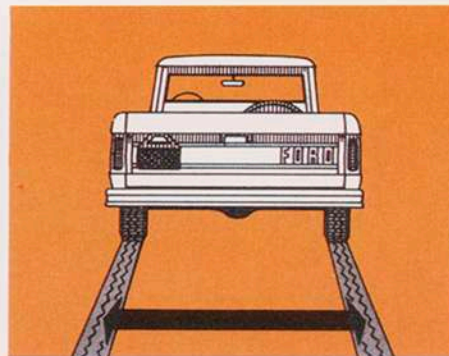

STABILITY . . . A wide 57.4-in. track for Bronco's front and rear axles reduces side sway on the highway and provides trail-hugging stability when traversing steep hills.

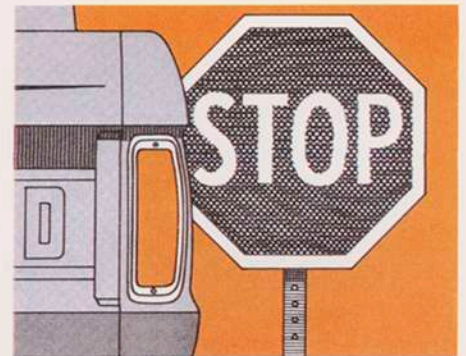

BRAKES . . . Bronco has big brakes for its class, 11 x 2 inches in front and 10 x 2½ inches in the rear for reliability and durability. Foot-pedal-operated parking brake is standard.

SUPERIOR OFF-ROAD ABILITY

Bronco has the ability to maneuver steep grades and uneven terrain without getting hung up or damaging the chassis, body or drive train components. Of prime importance are the angle of approach, angle of departure, ramp breakover angle, ground clearance and the particular point of contact involved in each case. Bronco's off-road ability advantages are shown in the comparison table below.

	BRONCO		SCOUT*	CJ-5 JEEP*
Tires	7.35x15	6.50x16	6.00x16	6.00x16
Wheelbase (WB)	92"	92"	100"	81"
Angle of Approach (AA)	40.6°	44.1°	47° (45.5°)	45°
Angle of Departure (AD)	27.7°	32.7°	35° (30.8°)	30°
Ramp Breakover Angle (RBA)	29.4°	31.9°	23.5° (25.2°)	30° (23.5°)
Ground Clearance (GC)				
Front Axle	7.65"	9.45"	9.25" (9.1")	8.62"
Rear Axle	6.6"	8.4"	9.125" (8.6")	8.0"
Sprung	11.6"	13.2"	10.4" (10.6")	9.2"
Turning Diameter (Bumper Clearance)	33.6'	33.6'	43'	36.6'

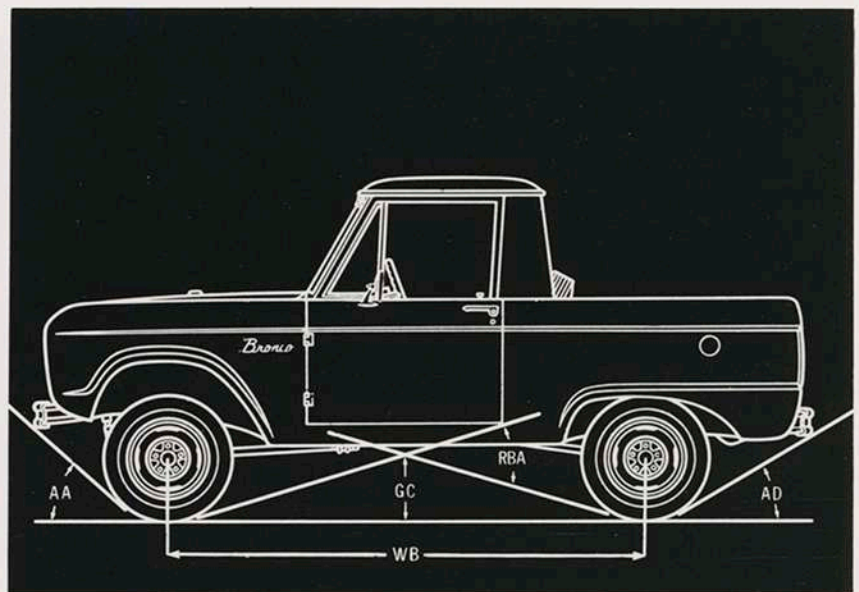

*Competitive figures shown above are based on 1965 vehicles and taken from published data book information. Figures shown in parentheses have been computed by Ford Engineering on the same basis as used in computing Bronco specifications.

BRONCO has spirited Big Six or V-8 power

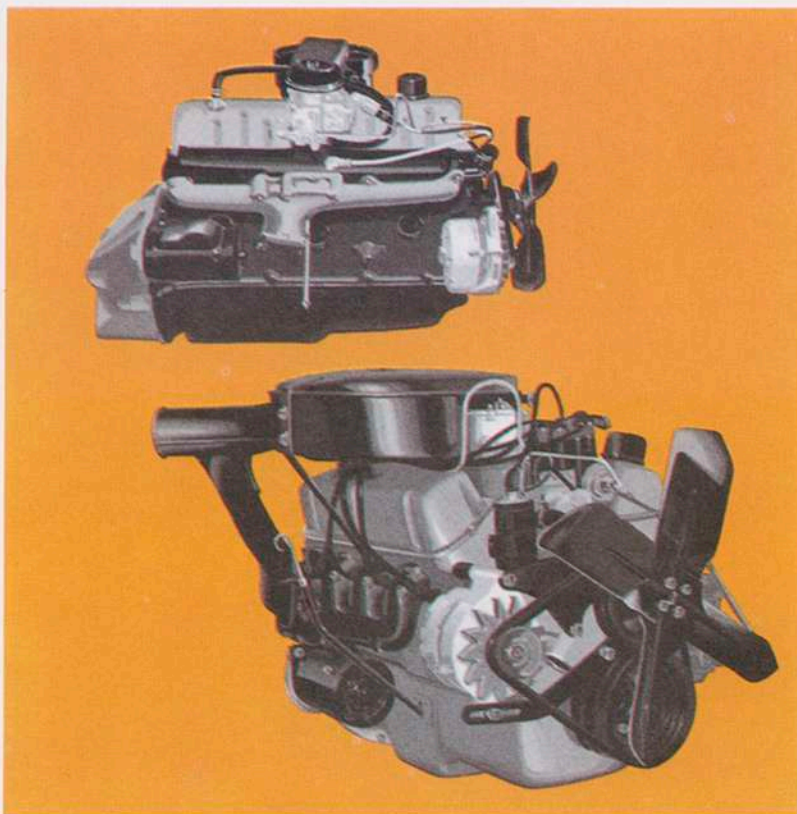

BIG SIX POWER . . . Bronco's 170-cu. in. 105-horsepower Six is the most powerful standard engine of any comparable American-built utility vehicle. This Six has plenty of power and stamina . . . the muscle you need in rough terrain and the smooth power you need for expressway cruising and passing.

BIGGER V-8 POWER . . . Available on all Bronco models by mid-March 1966 is an optional 289-cu. in. V-8. This rugged V-8, rated at 200 horsepower, will not only make sure winners of rally drivers but will give other sports enthusiasts extra power on any trip . . . whether pulling a trailer or just hauling sports-loving people. Furthermore, service station, ranch and farm owners will be able to tackle bigger chores . . . and do them more easily. Whatever engine you choose, Bronco will take you beyond the highway and back with power to spare!

Engine Specifications	170-cu. in. Six (Standard)	289-cu. in. V-8 (2V) (Optional)
Max. Gross HP @ RPM	105 @ 4400	200 @ 4400
Max. Net HP @ RPM	89 @ 3800	150 @ 4400
Max. Gross Torque (lbs-ft)	158 @ 2400	282 @ 2400
Max. Net Torque (lbs-ft)	146 @ 2400	242 @ 2400
Bore and Stroke (in.)	3.5 x 2.94	4.00 x 2.87
Compression Ratio	9.1 to 1	9.3 to 1

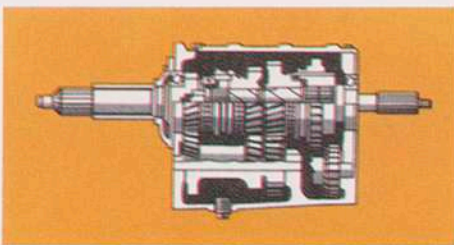

3-SPEED TRANSMISSION . . . Synchronized in all three forward speeds, Bronco's transmission can be downshifted into low without gear clash and without stopping and losing momentum when the going gets rough in mud, snow or on hills. The shift lever is on the steering column, leaving more clear space on the floor.

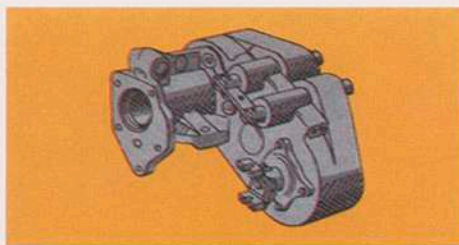

THROUGH-DRIVE TRANSFER CASE . . . When operating in 2-wheel drive, the front axle transfer case gears are free-running or disengaged. This minimizes gear noise and increases gear life. Double Cardan universal joints attach driveshafts to transfer case for smooth power flow, reduced vibration and greater durability.

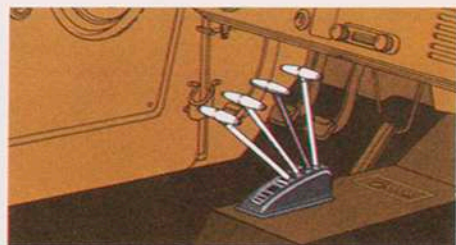

SINGLE SHIFT LEVER FOR TRANSFER CASE . . . Bronco's transfer case with single control lever can be shifted from 2-wheel drive to 4-wheel drive in high range without stopping or clutching. Transfer case T-bar shift lever provides a positive lock to prevent transfer case from possibly jumping out of four-wheel drive.

and long-life stamina !

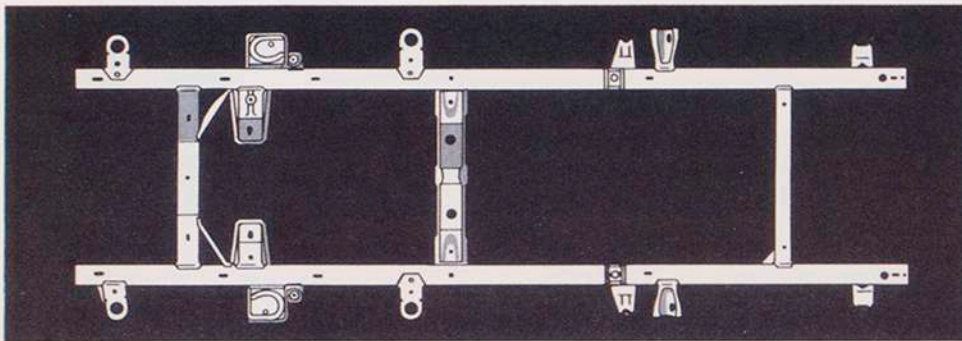

SOLID AND TOUGH FRAME . . .

Bronco has plenty of backbone! Frame is a complete box section through its entire length. Front and rear crossmembers are of box-section construction and are welded to siderails, reinforced with gussets to maintain frame alignment and provide extra strength.

Lubrication, oil and oil filter change required only every 6,000 miles under normal conditions. See your Ford Dealer for further service information.

PROTECTION UNDERNEATH . . . Front and rear bumpers establish angles of approach and departure as shown in drawing on page 7 . . . protect chassis and body components from damage by ground or other obstructions. Tube-type 6.50 x 16 6PR truck-type tires are available for maximum ground clearance. Heavy-gauge steel skid plates under the transfer case and fuel tank are also available for maximum protection for cross-country operations.

FRONT AND REAR AXLES . . . Standard front and rear axles on the Bronco are of a high capacity design for durability. In addition, a heavy-duty rear axle is available. Standard or optional axles are available with a limited-slip differential as a regular production option.

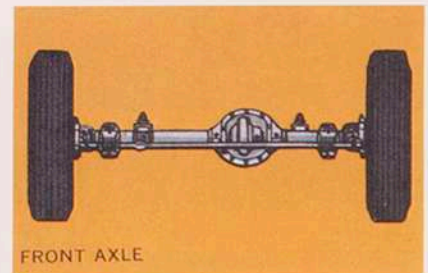
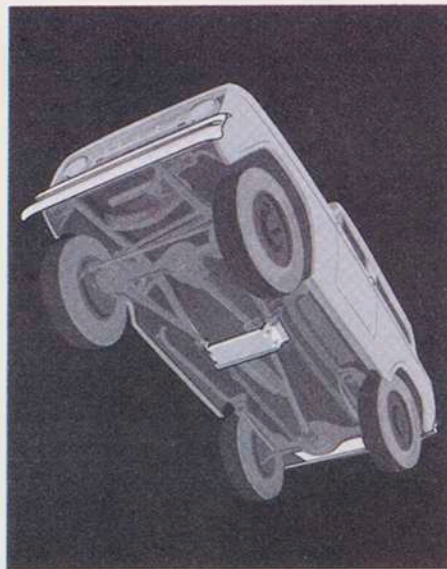

FRONT AXLE

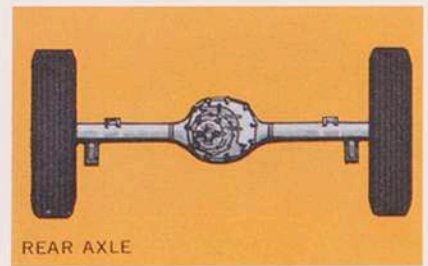

REAR AXLE

QUALITY BACKED BY 24,000-MILE OR 24-MONTH WARRANTY

BEST WARRANTY OF ANY VEHICLE OF ITS TYPE!

Ford Motor Company warrants to owners as follows: That for 24,000 miles or for 24 months, whichever comes first, free replacement, including related labor, will be made by Ford Dealers of any part with a defect in workmanship or material. Tires are not covered by the warranty; appropriate adjustments will be made by tire companies. Owners will remain responsible for normal maintenance services, routine replacement of parts such as filters, spark plugs, ignition points, wiper blades, brake or clutch linings, and for normal deterioration of soft trim and appearance items. The warranty referred to herein is applicable to products sold in the U.S.A. and in certain neighboring areas.

BRONCO has plenty of comfort . . .



BRONCO Accessories . . . Dealer Installed

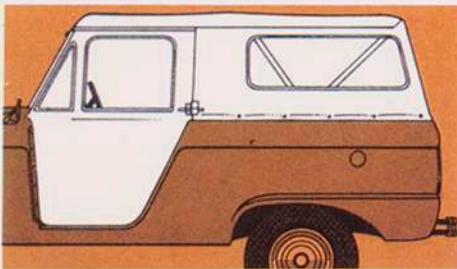

CONVERTIBLE TOP WITH VINYL DOORS AND PLASTIC WINDOWS . . . Order your Bronco Roadster with a full-length, folding vinyl convertible top and vinyl doors with plastic windows.

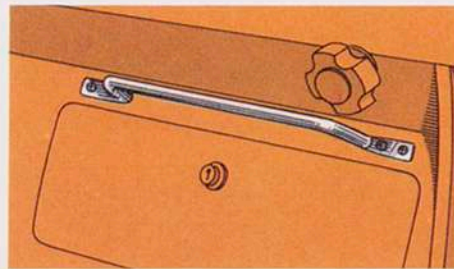

HANDRAIL, INSIDE . . . Your Ford Dealer will install attractive chrome handrails inside your Bronco for safety and convenience, if you wish. Passengers appreciate these on steep grades.

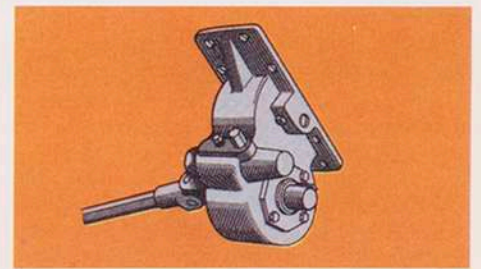

POWER TAKE-OFF . . . Operate a wide variety of auxiliary equipment with your Bronco. Power take-off drives can operate various front- or rear-mounted equipment.



COMPASS . . . You may wish to equip your Bronco with a compass. It will prove helpful, particularly when traveling cross country or through heavily wooded areas.

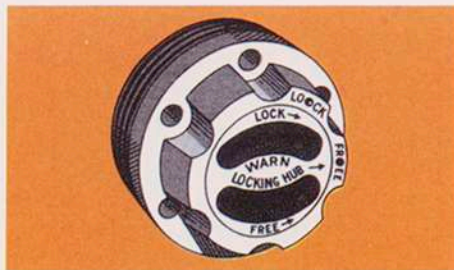

FREE-RUNNING HUBS . . . Free-running front hubs save wear on front axles when operating in 2-wheel drive. WARN free-running hubs are available as dealer-installed equipment.



2-WAY RADIO . . . Your Ford Dealer can install a 2-way radio in your Bronco so you can communicate with your home base or other vehicles in the field.

OPTIONAL BRONCO CUSTOM EQUIPMENT PACKAGE

- Chrome bumpers, front & rear
- Arm rests, RH & LH (Available with door models)
- Bright-metal taillight bezels
- Cigar-cigarette lighter
- Chrome horn ring
- Padded sun visors, RH & LH
- Bright-metal wheel covers on 15" wheels only

and convenience, too !

MORE LEGROOM FOR DRIVER AND PASSENGERS

Bronco offers more uncluttered legroom than any other utility vehicle. It seats three comfortably in front. The transmission shift lever is mounted out of the way on the steering column, and the transfer case is operated by a single, floor-mounted shift lever. The drive train hump is low, and the front seat has a full five-inch travel adjustment. Brake and clutch pedals are steering column centered. The back area is over 55 inches long and 56 inches wide, with ample room between wheelhousings for a two-passenger seat with plenty of legroom.

STANDARD CONVENIENCE FEATURES

- Weatherproof roof and windshield seals
- Padded dash
- Seat belts
- Front floor above door sills
- Large door windows—Sports Utility and Wagon
- LH outside rearview mirror
- Liftgate lock—Wagon
- Turn signals
- Dual windshield wipers w/dual vacuum motors and non-glare wiper arms
- Windshield washers
- Vinyl-covered rubber floor mat

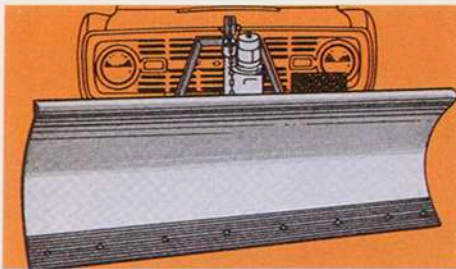

SNOWPLOW . . . Equip your Bronco with a snowplow. Controlled from the cab, the blade may be adjusted to various heights for most effective use. Power angling kit available.

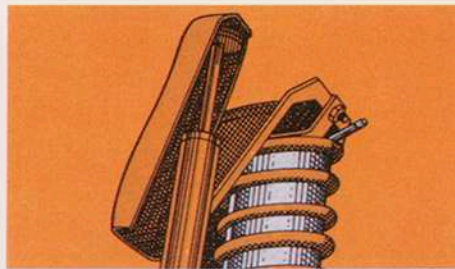

FRONT OVERLOAD AIR SPRINGS . . . Overload air springs may be installed in the front coil springs of your Bronco for increased capacity and for snowplow service.

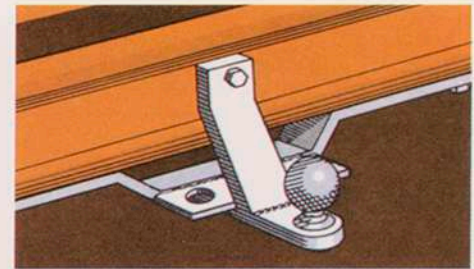

TRAILER HITCH . . . Your Bronco has plenty of power for towing a moderate-sized trailer. Trailer hitch is available for your added convenience at your Ford Dealer's.

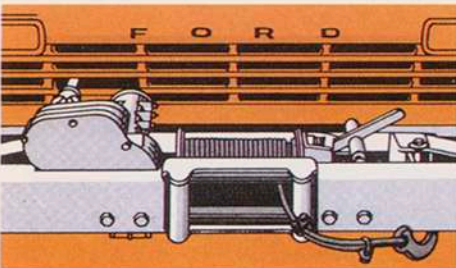

FRONT-MOUNTED WINCH . . . An 8000-pound-capacity winch is available for your Bronco. Winch has 150 feet of $\frac{3}{16}$ -inch cable to pull vehicles that are twice Bronco's own weight.

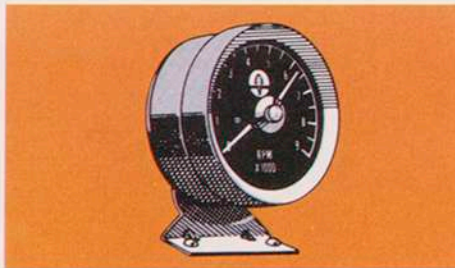

TACHOMETER . . . Especially valuable for rallies, a dealer-installed tachometer mounted to your dash will permit operation at maximum efficiency through all the gears.

ALSO . . .

- Fire Extinguisher
- Locking Gas Cap
- Map Light
- Tool Kit
- Front Tow Hooks (2)

OTHER POPULAR FACTORY-INSTALLED OPTIONS

Cab Equipment: LH & RH arm rests • Cigar lighter • Cab doors (w/ or w/o glass and frames—Roadster) • Horn ring • Inside rearview mirror • RH rearview mirror (Painted, all models—Chrome w/doors) • Manual radio & antenna • LH or LH & RH bucket seats • Bench-type rear seat (N.A. w/Sports Utility) • ICC lamp flashers* • Padded LH & RH sun visors • Fresh air heater and defroster.

*Included at extra cost unless otherwise specified.

Miscellaneous Equipment: Front and rear chrome channel bumpers • Front bumper guards, Chrome (w/chrome bumpers only) • Skid plates (under fuel tank and transfer case) • Inside tailgate-mounted spare tire carrier (incl. w/rear seat option) • Bright-metal wheel covers (15-inch wheels only) • High-flotation tires (9.15 x 15 4PR PT) • Auxiliary 12-gal. fuel tank. (Avail. May)

AUXILIARY EQUIPMENT

These items may be obtained through your Ford Dealer from equipment suppliers: Backhoe • Boom • Fire fighting equipment • Grass mower • Grille guard • Posthole digger • Rear step bumper • Rotary broom • Spray equipment • Trencher • Wrecker equipment

BRONCO specifications

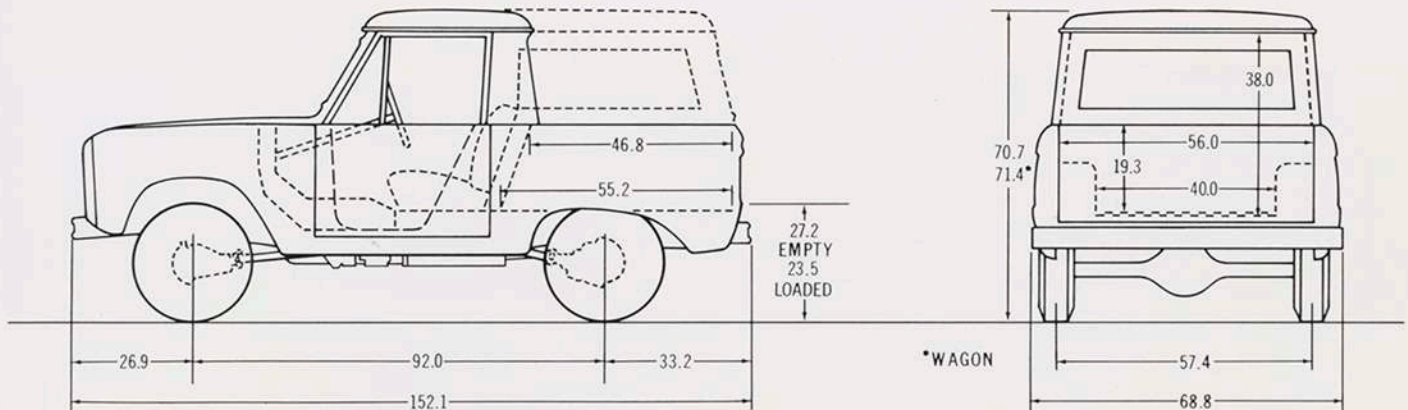

SPECIFICATIONS:

EQUIPMENT	STANDARD	OPTIONAL
ALTERNATOR:	38 amp., 570 watt	45 amp., 55 amp.
AXLE, FRONT: Capacity (lb.)	2500	Limited-Slip Requires Free-Running Hubs*
AXLE, REAR: Capacity (lb.), Ratio (to 1)	2780—4.11	2780—4.57, 3300*—3.50, 4.11 or 4.57
Ratios for 2780 and 3300 limited-slip	—	3.50, 4.11 or 4.57
BATTERY: (12 volts)	54 plates—45 amp-hr.	66 plates—55 or 70 amp-hr
BRAKES, SERVICE:		
Size (in.) front	11 x 2	—
rear	10 x 2½	—
BRAKES, PARKING: Type	Cable actuation of rear brakes	—
CLUTCH: Dia. (in.)	9 w/Six, 11 w/V-8*	HD 9¾ w/Six
ENGINE:	170-cu. in. Six	289-cu. in. V-8*
FRAME: Section Modulus	2.04	—
HUBS, FRONT:	—	Free-Running
SHOCK ABSORBERS: Front and Rear	Double-acting	—
SPRINGS, FRONT: Coil: Capacity @ pad (lb. ea.)	760 w/Six, 850 w/V-8*	850 w/Six, 950 w/V-8*
SPRINGS, REAR: Capacity @ pad (lb. ea.)	Progressive 930	Single-Stage 1280
STEERING: Gemmer	Worm & roller	—
TRANSFER CASE: Constant mesh, Dana 20	2-spd. thru-drive	—
TRANSMISSION: Fully synchronized, Ford	3-spd. direct	—
WHEELS: No.—type—rim size (in.)	5—5-hole disc—5½K	5—5-hole disc—5K**
TIRES:	Tubeless 7.35-15 4 PR PT	Tube-type 6.50-16 6PR TT**
STANDARD COLORS: Raven Black, Wimbledon White, Rangoon Red, Arcadian Blue, Springtime Yellow, Sahara Beige, Marlin Blue, Holly Green, Caribbean Turquoise, Peacock Blue, Light Turquoise, Poppy Red and Chrome Yellow. Bronco metal roofs are painted Wimbledon White to provide a two-tone paint combination.		
Optional: Bronco body paint stripe and rocker panel moldings or accent racing stripes.		

*Includes 11" x 13" rear brakes. **For maximum clearance and durability. For additional tire sizes see your Ford Dealer. *Available mid-March. PT=Passenger-type TT=Truck-type

NOTE: With standard equipment, Bronco has a GVW rating of 3900 lb. A special 4700 GVW package may be purchased as a unit. This package includes a Ford 3300-lb. rear axle, with 11" x 13½" rear brakes, 1280-lb. rear springs and 8.15 x 15 8PR tubeless tires.

A NETWORK OF ALMOST 6,400 FORD DEALERS TO SERVE YOU AND YOUR BRONCO!

Wherever you go, you'll always find one of almost 6,400 Ford Dealers nearby to serve you. This great network of Ford Dealers has the modern facilities, Ford-trained mechanics and replacement parts to provide quick, competent, preventive maintenance and repairs.

The specifications contained herein were in effect at the time this literature was approved for printing. Ford Division of Ford Motor Company reserves the right to discontinue models at any time or change specifications or design without notice and without incurring obligation. All options and accessories illustrated or referred to as optional or available in this literature are at extra cost. For the price of the model with the equipment you desire, see your Ford Dealer.

1966 Bronco . . . **Ford's** newest, most exciting, 4-wheel-drive all-purpose vehicle.