

ENGINES

Type
Configuration
Displacement, cm ³
Bore (mm)
Stroke (mm)
Engine cylinder block material
Cylinder head material
Compression ratio
Valves, no/cylinder
Camshafts
Engine management system
Ignition sequence
Engine idling speed, rpm
Fuel, rec. octane
Max output, kW (hp)/rpm
Max torque, Nm/rpm

T5 (B4204T23)
In-line 4-cyl. turbocharged
Transverse, front wheel drive
1969
82.0
93.2
Aluminium
Aluminium
10.8:1
4
2
Gasoline direct injection
1 - 3 - 4 - 2
850 ± 100
95-98 RON
187 (254)/5500
350/1500-4800

T6 AWD (B4204T27)
In-line 4-cyl. supercharged and turbocharged
Transverse, all wheel drive
1969
82.0
93.2
Aluminium
Aluminium
10.3:1
4
2
Gasoline direct injection
1 - 3 - 4 - 2
850 ± 100
95-98 RON
235 (320)/5700
400/2200-5400

T8 AWD (B4204T35)
In-line 4-cyl. supercharged and turbocharged
Transverse, front wheel drive, rear electric motor
1969
82.0
93.2
Aluminium
Aluminium
10.3:1
4
2
Gasoline direct injection
1 - 3 - 4 - 2
850 ± 100
95-98 RON
235 (320)/5700
400/2200-5400

POWER AND TORQUE →

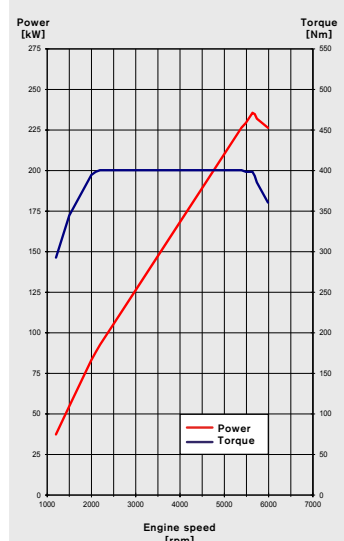
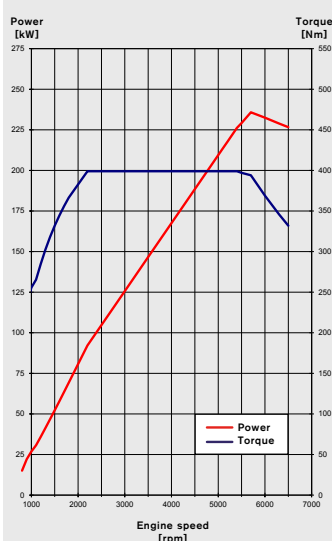
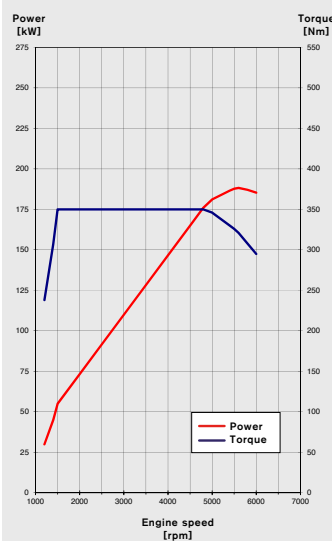

Manual gearbox/final drive
Automatic gearbox/final drive
PERFORMANCE
Gearbox
Acceleration, 0-100 km/h (sec)
Top speed, km/h
Fuel consumption l/100 km (Combined)
CO ₂ g/km

-	
AW TG-81SC	3.075
Automatic	
7.0	
230	
6.8	
154	

-	
AW TG-81SC	3.200
Automatic	
6.1	
250	
7.4	
169	

-	
AW TG-81SD	n/a
Automatic	
5.2	
n/a	
2.1	
47	

Battery type
Battery content, total amount of energy (kwh)
Battery charging time*, at 16A/10A/6A fuse (hours)
Range (Km) (NEDC for hybrids)
Electrical motor max power (kW/rps)
Electrical motor max torque (Nm/rps)
Driveline max power (hp)
Driveline max power (kW)
Driveline max torque (Nm)
Battery placement

Lithium-ion battery
9.2
2.5/3.5/6.0
>45 km**
65/117
240/0-50
~407 (320 + 87)
~300 (235*** + 65)
~640 (400*** + 240)
Centrally in the tunnel of the car

*) Time pending on e.g. ambient temp
 **) Pure electrical range according to NEDC cycle range
 ***) In "Hybrid"-, Power*- and "EL-AWD"-mode

ENGINES

Type
Configuration
Displacement, cm ³
Bore (mm)
Stroke (mm)
Engine cylinder block material
Cylinderhead material
Compression ratio
Valves, no/cylinder
Camshafts
Engine management system
Ignition sequence
Engine idling speed, rpm
Fuel, rec. octane
Max output, kW (hp)/rpm
Max torque, Nm/rpm

POWER AND TORQUE →

Manual gearbox/final drive
Automatic gearbox/final drive
PERFORMANCE
Gearbox
Acceleration, 0–100 km/h (sec)
Top speed, km/h
Fuel consumption l/100 km (Combined)
CO ₂ g/km

D4 (D4204T14)
In-line 4-cyl. twin turbo charge diesel
Transverse, front wheel drive
1969
82.0
93.2
Aluminium
Aluminium
15.8:1
4
2
i-Art common rail direct injection
1 - 3 - 4 - 2
825 ± 150
Cetane Number: Min 48*
140 (190)/4250
400/1750–2500

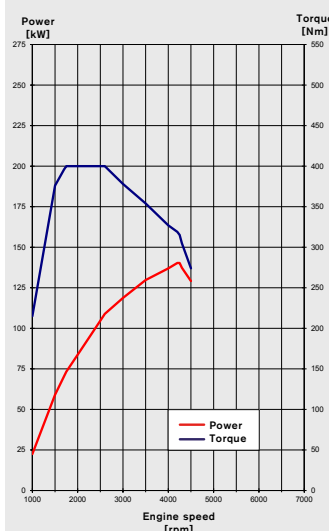

-	
AW TG-81SC	2.955
Automatic	
8.5	
225	
4.5	
119	

*) Maximum biodiesel (RME) content 7%

D5 AWD (D4204T23)
In-line 4-cyl. twin turbo charge diesel
Transverse, all wheel drive
1969
82.0
93.2
Aluminium
Aluminium
15.8:1
4
2
i-Art common rail direct injection
1 - 3 - 4 - 2
825 ± 150
Cetane Number: Min 48*
173 (235)/4000
480/1750–2250

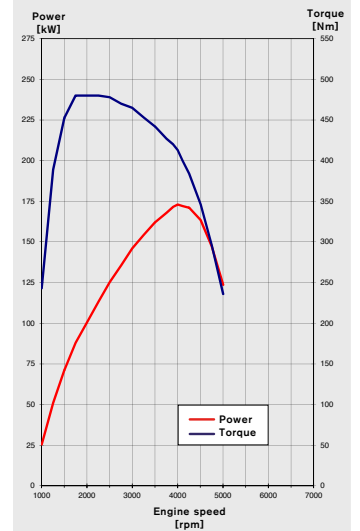

-	
AW TG-81SC	3.075
Automatic	
7.2	
240	
4.9	
129	

*) Maximum biodiesel (RME) content 7%

TRANSMISSIONS

8-speed automatic gearbox

RATIO	AW TG-81SC	AW TG-81SD
First	5.250	5.250
Second	3.029	3.029
Third	1.950	1.950
Fourth	1.457	1.457
Fifth	1.221	1.221
Sixth	1.000	1.000
Seventh	0.809	0.809
Eighth	0.673	0.673
Reverse	4.015	4.015

MEASUREMENTS AND VOLUMES

EXTERIOR MEASUREMENTS (CM)

Length	493.6
Width (door mouldings)	189.0
Width (Incl mirrors, outhter edge)	201.9
Height (including shark fin)	147.5
Wheelbase	294.1
Overhang (Front/Rear)	87.3/112.2
Track, front, (16"/17"+18"/19"+20"/21")	163.9/162.9 / 161.8/162.4
Track, rear, (16"/17"+18"/19"+20"/21")	163.9/162.9 / 161.8/162.4
Ground clearance, curb	15.3

WEIGHTS/MISCELLANEOUS

Weight, kg (min-max, depending on setup)	1825-2100
Fuel tank, l (FWD/AWD/B4204T35)	55/60/n/a
Max. trailer weight, kg	1800-2200*
Max roof load, kg	100
Drag coefficient, Cd	0.31

* TOWKIT required, otherwise 1800 kg

INTERIOR MEASUREMENTS (CM)

Headroom without sunroof (front/rear) (H61-1/H61-2)	98.3/96.6
Headroom maximum, without sunroof (front) (H62-1)	102.6
Passenger compartment width at shoulder height (front/rear) (W3-1/W3-2)	146.0/142.0
Leg room (front/rear) (L34/L51-2)	107.1/91.1
Luggage volume, including under floor storage	1526
Cargo length from the first seatback to the tailgate (SAE L202-1)	198.8
Cargo length from the second seatback to the tailgate (L202-2)	115.3
Cargo floor height to ground (H253)	61.0
Width of luggage compartment between wheelhouses (W202)	110.0

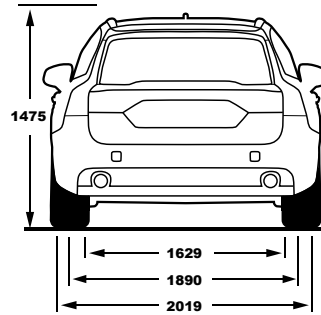
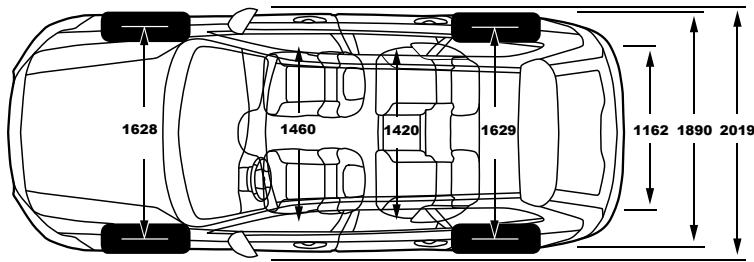
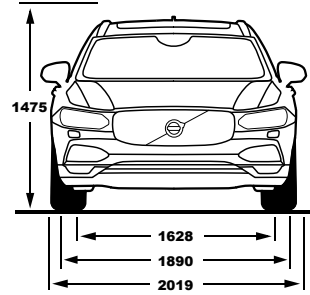
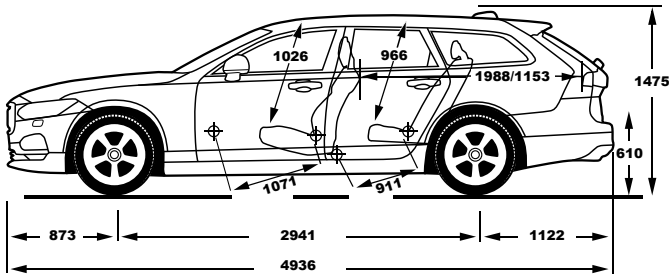

CHASSIS

Suspension	front	Double Wishbone Suspension, Coil Springs, Hydraulic Shock Absorbers, Stabilizer Bar.
	rear	Integral Axle with Transverse Composite Leaf Spring, Hydraulic Shock Absorbers, Stabilizer Bar, Optional Air Suspension
Steering	Electric Power Assisted Rack and Pinion Steering	
Turning circle, curb to curb (m)	11.4-11.8	
Braking system	Antilock Braking System (ABS) with Electronic Brake Distribution (EBD) and Electronic Brake Assistance (EBA)	
Braking distance, 100-0 km/h (m)	35	
Brake disc diameter (mm)	front	296/322/345 (Brake disc; 16",17",18")
	rear	302/320 (Brake disc; 16",17")